

ESTRATTO
CATALOGO
N°38

Flat

flat

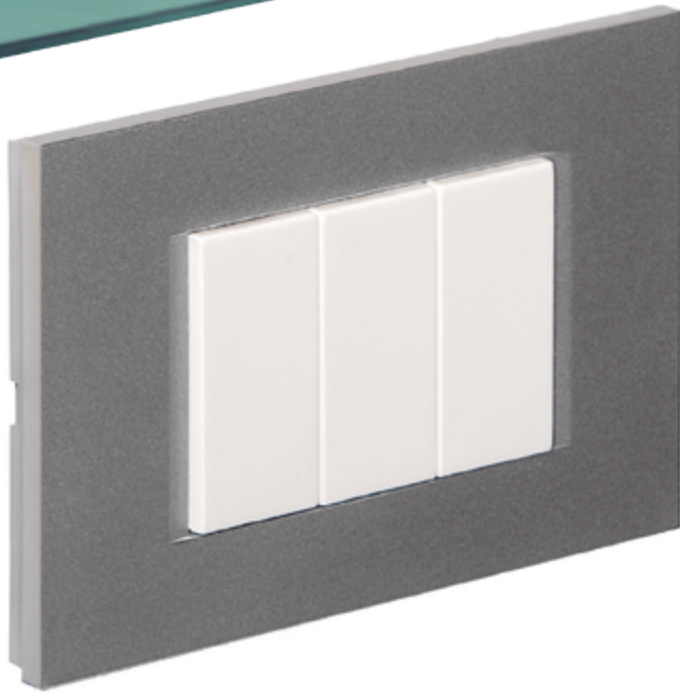



La serie **FLAT** è molto moderna ed essenziale, con linee eleganti e pulite. È disponibile in due versioni: LINE più tesa ed essenziale LUMINA, molto tecnica e squadrata, finitura trasparente, con effetto cristallino per un maggior risalto del colore. Il design raffinato si sviluppa in un ampio sistema modulare, che copre ogni esigenza di installazione.

The FLAT series is quite modern and essential, with elegant and clean lines. It is available in two versions: LINE more straight and more minimal. LUMINA with technical and square lines and a crystal like appearance that highlights the colors. The sophisticated design is developed into a wide modular system, that satisfies any requirement from installers.

flat

Interruttori e pulsanti / Switches and push buttons



70001	70001/TEC	70001/N	70031	70031/TEC	70031/N	70061	70061/TEC	70061/N	70091	70091/TEC	70091/N
Interruttore unipolare Switch - 1 way			Deviatore unipolare Switch - 2 way			Invertitore unipolare Switch - Intermediate			Interruttore bipolare Switch - 2 pole		
16AX 250V~ P = 29 mm			16AX 250V~ P = 29 mm			16AX 250V~ P = 29 mm			16AX 250V~ P = 29 mm		
CONFEZIONE / BOX: 10 PZ IMBALLO / PACKAGE: 300 PZ			CONFEZIONE / BOX: 10 PZ IMBALLO / PACKAGE: 300 PZ			CONFEZIONE / BOX: 10 PZ IMBALLO / PACKAGE: 300 PZ			CONFEZIONE / BOX: 10 PZ IMBALLO / PACKAGE: 300 PZ		

70121	70121/TEC	70121/N	70131	70131/TEC	70131/N	70151	70151/TEC	70151/N	70161	70161/TEC	70161/N
Interruttore unipolare illuminabile Switch - 1 way indicator			Deviatore unipolare illuminabile Switch - 2 way indicator			Interruttore bipolare illuminabile Switch - 2 pole indicator			Invertitore bipolare illuminabile Switch - Intermediate indicator		
16AX 250V~ P = 29 mm			16AX 250V~ P = 29 mm			16AX 250V~ P = 29 mm			16AX 250V~ P = 29 mm		
CONFEZIONE / BOX: 10 PZ IMBALLO / PACKAGE: 300 PZ			CONFEZIONE / BOX: 10 PZ IMBALLO / PACKAGE: 300 PZ			CONFEZIONE / BOX: 10 PZ IMBALLO / PACKAGE: 300 PZ			CONFEZIONE / BOX: 10 PZ IMBALLO / PACKAGE: 300 PZ		









70181	70181/TEC	70181/N	7022	70221/TEC	70221/N	70231	70231/TEC	70231/N	70211/NC	70211/NC/TEC	70211/NC/N
Pulsante unipolare illuminabile Push button - 1 way indicator			Doppio pulsante NO NO push button - Twin 1 pole			Doppio interruttore Switch - Twin 2 pole			Pulsante unipolare NC Push button - NC 1 way		
16AX 250V~ P = 29 mm			16AX 250V~ P = 44 mm			16AX 250V~ P = 44 mm			16AX 250V~ P = 29 mm		
CONFEZIONE / BOX: 10 PZ IMBALLO / PACKAGE: 300 PZ			CONFEZIONE / BOX: 10 PZ IMBALLO / PACKAGE: 300 PZ			CONFEZIONE / BOX: 10 PZ IMBALLO / PACKAGE: 300 PZ			CONFEZIONE / BOX: 10 PZ IMBALLO / PACKAGE: 300 PZ		

70241/N	70241/TEC	70241	70211	70211/TEC	70211/N	70241/I/N	70241/I/TEC	70241/I
Pulsante a corda NO NO push button with cord			Pulsante unipolare NO NO push button - 1 way			Interruttore unipolare a tirante Pull switch with cord		
16A 250V ~ 1P/NO P = 29 mm			16AX 250V ~ P = 29 mm			2A 250V ~ P = 29 mm		
CONFEZIONE / BOX: 10 PZ IMBALLO / PACKAGE: 160 PZ			CONFEZIONE / BOX: 10 PZ IMBALLO / PACKAGE: 300 PZ			CONFEZIONE / BOX: 1PZ IMBALLO / PACKAGE: 1PZ		









Pulsanti con portanome / Name holder push button





		
7025	7025/TEC	7025/N
Pulsante con portanome / Name holder push button		
16A 250V~ 1P/N0 P= 29 mm		
CONFEZIONE / BOX: 5 PZ		IMBALLO / PACKAGE: 150 PZ

Prese di corrente / Power sockets

								
70451	70451/TEC	70451/N	70391	70391/TEC	70391/N	70501	70501/TEC	70501/N
Presse di sicurezza STD italiano P11/17 2P+T Shuttered socket - Italian STD 2P+E PI 1/17			Presse di sicurezza 2P+T Tipo P11 Shuttered 2P+E socket - Italian standard P11			Presse di sicurezza universale STD ita+schuko 2P+T Shuttered socket universal STD - Italian+schuko 2P+E		
10-16A 250V~ P= 31 mm			10A 250V~ P= 31 mm			10-16A 250V~ P= 35,5 mm		
CONFEZIONE / BOX: 10 PZ IMBALLO / PACKAGE: 300 PZ			CONFEZIONE / BOX: 10 PZ IMBALLO / PACKAGE: 300 PZ			CONFEZIONE / BOX: 10 PZ IMBALLO / PACKAGE: 160 PZ		

Accessori / Accessories

								
70801	70801/TEC	70801/N	70901/3	70901/3/TEC	70901/3/N	70901/4	70901/4/TEC	70901/4/N
Tappo copriforo / Blank cap			Copritasto / Key cover			Copritasto illuminabile / Indicator key cover		
P= 13 mm								
CONFEZIONE / BOX: 20 PZ IMBALLO / PACKAGE: 480 PZ			CONFEZIONE / BOX: 10 PZ IMBALLO / PACKAGE: 210 PZ			CONFEZIONE / BOX: 10 PZ IMBALLO / PACKAGE: 210 PZ		

			
4000/LN	4000/LL	4000/LL/BL	4000/LL/12
Lampada spia neon - cavo mm 100 Indicator neon lamp with 100mm cable	Lampada spia led bianco - cavo mm 100 Indicator white led lamp with 100mm cable	Lampada spia led blu - cavo mm 100 Indicator blu led lamp with 100mm cable	Lampada spia led bianco - cavo mm 100 Indicator white led lamp with 100mm cable
230V-ø= 8,5 mm	230V-ø= 8,5 mm	230V-ø= 8,5 mm	12V ac/dc ø= 8,5 mm
CONFEZIONE / BOX: 1 PZ IMBALLO / PACKAGE: 100 PZ	CONFEZIONE / BOX: 1 PZ IMBALLO / PACKAGE: 100 PZ	CONFEZIONE / BOX: 1 PZ IMBALLO / PACKAGE: 100 PZ	CONFEZIONE / BOX: 1 PZ IMBALLO / PACKAGE: 100 PZ
4000/LN/10	4000/LL/10	4000/LL/BL/10	4000/LL/12/10
CONFEZIONE / BOX: 1 PZ IMBALLO / PACKAGE: 100 PZ	CONFEZIONE / BOX: 1 PZ IMBALLO / PACKAGE: 100 PZ	CONFEZIONE / BOX: 1 PZ IMBALLO / PACKAGE: 100 PZ	CONFEZIONE / BOX: 1 PZ IMBALLO / PACKAGE: 100 PZ

flat



Accessori / Accessories

											
70901/9	70901/9/TEC	70901/9/N	70901/10	70901/10/TEC	70901/10/N	70901/11	70901/11/TEC	70901/11/N	70901/12	70901/12/TEC	70901/12/N
Copritasto pulsante simbolo chiave Key cover for push button with key symbol			Copritasto pulsante simbolo luce Key cover for push button with lamp symbol			Copritasto pulsante simbolo campanello Key cover for push button with bell symbol			Copritasto pulsante simbolo infermiera Key cover for push button with nurse symbol		
CONFEZIONE / BOX: 10 PZ IMBALLO / PACKAGE: 300 PZ			CONFEZIONE / BOX: 10 PZ IMBALLO / PACKAGE: 300 PZ			CONFEZIONE / BOX: 10 PZ IMBALLO / PACKAGE: 300 PZ			CONFEZIONE / BOX: 10 PZ IMBALLO / PACKAGE: 300 PZ		

Suonerie e ronzatori / Bells and buzzers

											
7072/10	7072/10/TEC	7072/10/N	7072/1	7072/1/TEC	7072/1/N	7075/10	7075/10/TEC	7075/10/N	7075/1	7075/1/TEC	7075/1/N
Suoneria Funzionamento intermittente Ringing bell - Intermittent operation			Suoneria Funzionamento intermittente Ringing bell - Intermittent operation			Ronzatore Funzionamento intermittente Buzzer - Intermittent operation			Ronzatore Funzionamento intermittente Buzzer - Intermittent operation		
220V 50Hz 8VA			12V 50Hz 8VA			220V 50Hz 8VA			12V 50Hz 8VA		
P = 39,5mm			P = 39,5mm			P = 39,5mm			P = 39,5mm		
CONFEZIONE / BOX: 1 PZ IMBALLO / PACKAGE: 10 PZ			CONFEZIONE / BOX: 1 PZ IMBALLO / PACKAGE: 10 PZ			CONFEZIONE / BOX: 1 PZ IMBALLO / PACKAGE: 10 PZ			CONFEZIONE / BOX: 1 PZ IMBALLO / PACKAGE: 10 PZ		

Apparecchi di segnalazione luminosa / Light signaling devices

		
7059	7060	70691
LED luce bianca / LEDs white light	LED luce bianca / LEDs white light	
Lampada estraibile a LED impostabile come luce notturna o come segnalazione. Portable LED lamp, externally switchable as night or step lamp.	Lampada LED impostabile come luce di emergenza (intensità 100%) o notturna (intensità 30%). Estraibile. LED lamp,, externally switchable as emergency (intensity 100%) or night lamp (intensity 30%). Portable.	Luce segnalazione LED bianca White LED courtesy light
50-60 Hz 230V ~	50-60 Hz 230V ~	3W 230V ~
P= 47,5 mm	P= 47,5 mm	P= 29 mm
CONFEZIONE / BOX: 1 PZ IMBALLO / PACKAGE: 10 PZ	CONFEZIONE / BOX: 1 PZ IMBALLO / PACKAGE: 10 PZ	CONFEZIONE / BOX: 1 PZ IMBALLO / PACKAGE: 5 PZ

Termostati / Thermostats





			
7063	7064	7064/TEC	7064/N
Termostato analogico 3M <i>Analog thermostat 3M</i>	Cronotermostato 24H/7GG 3M <i>Chronothermostat 24H/7D 3M</i>		
Alimentazione con 2 pile AA 1,5 V Regolazione temperatura da 5° a 30° C Uscita relè in scambio NO/COM e NC 6 A 250 Vac <i>Power supply 2 AA batteries 1,5 V Regulated temperature range from 5° to 30° C</i>	Alimentazione con 2 pile AA 1,5 V Regolazione temperatura da 2° a 35° C Uscita relè in scambio NA/COM e NC 6 A 250 Vac <i>Power supply 2 AA batteries 1,5 V Regulated temperature range from 2° to 35° C Relay output in exchange NO/COM and NC 6 A 250Vac</i>		
P = 44,5 mm	P = 46,5 mm		
CONFEZIONE / BOX: 1 PZ IMBALLO / PACKAGE: 100 PZ	CONFEZIONE / BOX: 1 PZ IMBALLO / PACKAGE: 5 PZ		

Sensori / Sensors

	Interruttore a infrarossi con relè N.A. <i>IR sensor switch with N.O. relay</i>	Carichi elettrici comandabili: - Lampade incandescenza 800W - Lampade fluorescenti e CFL 200W <i>Compatible electric loads: - Incandescent lamp 800W - Fluorescent lamp and CFL 200W</i>
7065	5A 230V ~ P= 39,5mm	CONFEZIONE / BOX: 1 PZ IMBALLO / PACKAGE: 1 PZ

ACCESSORI PER HOTEL HOTEL ACCESSORIES

Interruttori a badge / Badge switch

			
1805 1805/TEC 1805/N	7067	7100	7066
Interruttore a badge 3M - Relè 30A - 230V <i>Badge switch 3M - Relè 30A - 230V</i>	Interruttore a badge mod. RF 13,56 Mhz 3M <i>Badge switch RF type 13,56 Mhz - 3M</i>	Relè per interruttore a badge barra DIN <i>Relay for badge switch 250V DIN bar</i>	Preso rasoio EU/USA 3M <i>Shaver socket EU/USA - 3M</i>
P = 34,5 mm	P = 34,5 mm	2x15A 250V~	L 70,0 x P 58,0 x H 86,0
CONFEZIONE / BOX: 1 PZ IMBALLO / PACKAGE: 1 PZ	CONFEZIONE / BOX: 1 PZ IMBALLO / PACKAGE: 1 PZ	CONFEZIONE / BOX: 1 PZ IMBALLO / PACKAGE: 1 PZ	CONFEZIONE / BOX: 1 PZ IMBALLO / PACKAGE: 5 PZ

Spie luminose / Pilot lights

71101	71102	7027	7027/TEC	7027/N	7027/V	7027/V/TEC	7027/V/N
Lampada verde fuoriporta Make Up Room <i>Green Make Up Room signal light</i>	Lampada rossa fuoriporta Do Not Disturb <i>Red Do Not Disturb signal light</i>	Spia luminosa al neon rossa <i>Red pilot light with neon lamp</i>			Spia luminosa al neon verde <i>Green pilot light with neon lamp</i>		
3W 230V~	P = 29 mm	230V~	P = 21 mm		230V~	P = 21 mm	
CONFEZIONE / BOX: 1 PZ IMBALLO / PACKAGE: 5 PZ		CONFEZIONE / BOX: 10 PZ IMBALLO / PACKAGE: 120 PZ					









Prese TV e SAT / Television & satellite sockets

70481	70481/TEC	70481/N	7051/SAT	7051/SAT/TEC	7051/SAT/N	7053/SAT	7053/SAT/TEC	7053/SAT/N
Presa TV IEC maschio <i>Socket TV-IEC type male</i>			Presa terminale TV SAT maschio <i>Socket TV-SAT endline 1db</i>			Presa SAT tipo F femmina <i>Socket SAT F-type female</i>		
P = 12,5 mm			P = 25,5 mm			P = 13 mm		P = 35,5 mm
CONFEZIONE / BOX: 10 PZ		IMBALLO / PACKAGE: 240 PZ						

Prese TV e SAT / Television & satellite sockets

7051/1	7055	7055/TEC	7055/N
Presa passante TV SAT maschio <i>Socket TV-SAT through 10db</i>	Presa demiscelata TV SAT terminale - Connettore maschio (IEC 169-2) - Totalmente schermata per impianti tradizionali e satellitari - Attenuazione 1 dB - TV (40-860 MHz) - Connettore femmina tipo F (IEC 169-24) - Attenuazione 20 dB - SAT (950-2250 MHz)		Demix TV SAT socket-wall terminal - Male connector (IEC 169-2) - Totally shielded for traditional or satellite TV systems - Signal attenuation 1dB - TV (40-860 MHz) - Female connector type F (IEC 169-24) - Signal attenuation 20 dB - SAT (950-2250 MHz)
P = 25 mm	P = 25,5 mm		
CONFEZIONE / BOX: 10 PZ IMBALLO / PACKAGE: 100 PZ	CONFEZIONE / BOX: 10 PZ IMBALLO / PACKAGE: 240 PZ		

Prese TV e SAT / Television & satellite sockets





								
7082	7082/TEC	7082/N	7083	7083/TEC	7083/N	7083/2	7083/2/TEC	7083/2/N
Presca telefonica RJ11 connettore 6/4 Telephone socket RJ11 jack 6/4			Presca rete RJ45 CAT6A keystone Socket RJ45 8/8 CAT6A keystone			Adattatore keystone Keystone adapter		
P = 23,0 mm			P = 23,0 mm			P = 11 mm		
CONFEZIONE / BOX: 10 PZ IMBALLO / PACKAGE: 240 PZ			CONFEZIONE / BOX: 10 PZ IMBALLO / PACKAGE: 240 PZ			CONFEZIONE / BOX: 10 PZ IMBALLO / PACKAGE: 240 PZ		
Per schema vedere pag. 15 / For the scheme please see page 15								

Alimentatore USB tipo C / USB type C power supply

				<ul style="list-style-type: none"> - Alimentazione: 100-240 V, 50-60 Hz - Uscita: 5V 3A, 9V 2A, 12V 1.5A - Potenza continua: 20W - Protezione da corto circuito e sovraccarico - Si possono alimentare smartphone e tablet 	<ul style="list-style-type: none"> - Power supply: 100-240 V, 50-60 Hz - Output: 5V 3A, 9V 2A, 12V 1.5A - Continuous power: 20W - Protection: short circuit overload - Able to charge smartphone and tablets
7087	7087/TEC	7087/N	vista laterale / side view		
Alimentatore 1 presa USB tipo C - Power delivery 20W USB type C charger 1 outlet - Power delivery 20W			P = 32 mm	CONFEZIONE / BOX: 1PZ IMBALLO / PACKAGE: 40 PZ	

Alimentatore USB / USB power supply

				<ul style="list-style-type: none"> - Alimentazione: 100-240 VAC, 50-60 Hz - Uscita: 5Vdc 2,1 A - Potenza: 10W - Protezione da corto circuito e sovraccarico - Richiede scatole profonde 47 mm min. - Si possono alimentare smartphone e tablet 	<ul style="list-style-type: none"> - Power supply: 100-240 VAC, 50-60 Hz - Output: 5Vdc 2,1 A - Continuous power: 10W - Protection: short circuit overload - Requires boxes 47 mm deep min. - Able to charge smartphone and tablets
7086	7086/TEC	7086/N	vista laterale / side view		
Alimentatore 1 presa USB - 5V 2,1 A USB charger 1 outlet - 5V 2,1 A			P = 45 mm	CONFEZIONE / BOX: 1PZ	IMBALLO / PACKAGE: 40 PZ
Connettore bianco / White jack					

			
7088	7088/TEC	7088/N	vista laterale / side view
Alimentatore 2 prese USB - 5V 2X 1,2A o 1X 2,4 A		USB charger 1 outlet - 5V 2X 1,2A o 1X 2,4 A	
<ul style="list-style-type: none"> - Alimentazione: 100-240 VAC, 50-60 Hz - Uscita: 5Vdc 2,4 A - Potenza: 12W - Efficienza: 70% Energy Star 2 - Protezione da corto circuito e sovraccarico - EMI conforme a EN55022 - EMS conforme a EN61000 - Richiede scatole profonde 47mm min. - Si possono alimentare smartphone e tablet 		<ul style="list-style-type: none"> - Power supply: 100-240 VAC, 50-60 Hz - Output: 5Vdc 2,4 A - Continuous power: 12W - Efficiency: 70% Energy Star 2 - Protection: short circuit overload - EMI compliant with EN55022 - EMS compliant with EN61000 - Requires boxes 47 mm deep min. - Enable to charge smartphone and tablets 	
P = 45 mm		CONFEZIONE / BOX: 1PZ IMBALLO / PACKAGE: 40 PZ	



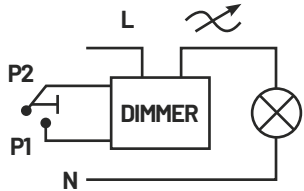



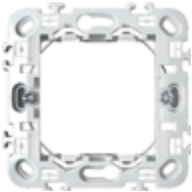

Dimmer universale / Universal dimmer

		<p>Descrizione Dimmer universale da fondo scatola, può essere collegato ai morsetti di uno o più pulsanti NO.</p> <p>Funzionamento Collegare uno o più pulsanti NO ai cavi verdi del dimmer. Tenendo premuto il pulsante, il carico aumenta la luminosità dal minimo al massimo. Con una pressione singola il carico si spegne e con una nuova pressione singola si riaccende all'ultimo valore impostato.</p> <p>Carichi compatibili LED dimmerabili: 10 -150 VA; 220-240V; Carichi resistivi: 10 -300 VA; 220-240V; Luci alogene con trasformatore: 10 -300VA; 220-240V.</p>	<p>Description Universal dimmer to be connected to one or more NO push buttons.</p> <p>Operation Connect one or more NO push button to the green wires on the dimmer. By pushing the button, the load will increase the brightness from the minimum to the maximum. With a single push the load is turned off and with a new push it is turned back on to the last value that was set.</p> <p>Compatible loads Dimmable LEDs: 10-150 VA; 220-240V; Resistive loads: 10-300 VA; 220-240V; Halogen lights with transformer: 10-300 VA; 220-240V.</p>
<p>1705</p>			
<p>Dimmer Universale Universal Dimmer</p>			
<p>10 - 300 VA - 220-240V</p>			
<p>CONFEZIONE / BOX: 1 PZ IMBALLO / PACKAGE: 40 PZ</p>			

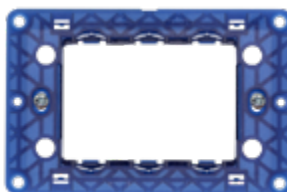
Circuito RC per dimmer / Dimmer RC circuit

	<p>Descrizione Circuito RC per eliminare disturbi nell'utilizzo di luci LED. In caso di utilizzo di più luci LED di potenza complessiva superiore a 10W, ma individuale inferiore, può succedere che alcune rimangano accese anche a dimmer spento. Per prevenire questo effetto, collegare in parallelo alle luci il circuito RC 1706.</p> <p>Caratteristiche tecniche: Resistenza 22 Ω - Capacità 100nF</p>	<p>Description RC circuit used to eliminate disturbances due to LED lights. In case of the use of several LED lights with total power above 10W, but individual power below 10W, it can happen that one or more remain slightly on even when the dimmer is off. In this case, to prevent this from happening, connect the RC circuit 1706 in parallel with the lights.</p> <p>Technical features: Resistance 22Ω - Capacity 100nF</p>
<p>1706</p>	<p>Dimensioni: 25,0 x 18,5 x 9,0 mm</p>	<p>Dimensions: 25,0 x 18,5 x 9,0 mm</p>
<p>CONFEZIONE / BOX: 1PZ - IMBALLO / PACKAGE: 40 PZ</p>		







SUPPORTI / FRAMES

			
<p>76021 </p>		<p>76031 </p>	
<p>Supporto per scatola tonda 2M Mounting frame for round box 2M</p>		<p>Supporto 3M Mounting frame 3M</p>	
<p>Dimensioni: 75,0 x 75,0 mm Dimensions: 75,0 x 75,0 mm</p>	<p>CONFEZIONE / BOX: 36 PZ IMBALLO / PACKAGE: 576 PZ</p>	<p>Dimensioni: 112,0 x 72,5 mm Dimensions: 112,0 x 72,5 mm</p>	<p>CONFEZIONE / BOX: 30 PZ IMBALLO / PACKAGE: 480 PZ</p>
			
<p>76041 </p>		<p>76071 </p>	
<p>Supporto 4M Mounting frame 4M</p>		<p>Supporto 7M Mounting frame 7M</p>	
<p>Dimensioni: 135,0 x 72,5 mm Dimensions: 135,0 x 72,5 mm</p>	<p>CONFEZIONE / BOX: 20 PZ IMBALLO / PACKAGE: 320 PZ</p>	<p>Dimensioni: 203,0 x 72,5 mm Dimensions: 203,0 x 72,5 mm</p>	<p>CONFEZIONE / BOX: 12 PZ IMBALLO / PACKAGE: 192 PZ</p>







SCATOLE DA ESTERNO/PARETE
OUTDOOR BOXES/WALL MOUNT

flat

Coperchi IP55 2M / IP55 2M Covers			Scatole IP55 2M / IP55 2M Boxes		
					
12805/WH	12805/G	12805/GS	11962/WH	11962/G	11962/GS
Coperchio autoportante multi-serie da esterno IP55 2M <i>Outdoor multi-series cover with lid IP55 2M</i> 96,0 x 96,0 x h 20,0 mm			Scatola multi-serie da esterno con coperchio IP55 2M <i>Outdoor multi-series surface mount box with cover IP55 2M</i> 96,0 x 96,0 x h 73,0 mm		
CONFEZIONE / BOX: 14 PZ		IMBALLO / PACKAGE: 56 PZ	IMBALLO / PACKAGE: 10 PZ		



Scatole IP40 2M / IP40 2M Boxes					
					
11952/WH	11952/G	11952/GS	12802/WH	12802/G	12802/GS
Scatola multi-serie da parete con placca IP40 2M <i>Multi-series surface mount box with cover plate IP40 2M</i> 96,0 x 96,0 x h 60,0 mm			Scatola multi-serie da parete 2M <i>Multi-series surface mount box 2M</i> 96,0 x 96,0 x h 51,0 mm		
IMBALLO / PACKAGE: 16 PZ			IMBALLO / PACKAGE: 16 PZ		

Coperchi IP55 3M / IP55 3M Covers			Scatole IP55 3M / IP55 3M Boxes		
					
12806/WH	12806/G	12806/GS	11963/WH	11963/G	11963/GS
Coperchio autoportante multi-serie da esterno IP55 3M <i>Outdoor multi-series cover with lid IP55 3M</i> 128,0 x 96,0 x h 20,0 mm			Scatola multi-serie da esterno con coperchio IP55 3M <i>Outdoor multi-series surface mount box with cover IP55 3M</i> 128,0 x 96,0 x h 73,0 mm		
CONFEZIONE / BOX: 10 PZ		IMBALLO / PACKAGE: 40 PZ	IMBALLO / PACKAGE: 15 PZ		







Scatole IP40 3M / IP40 3M Boxes			Scatole IP40 / IP40 Boxes		
					
11953/WH	11953/G	11953/GS	12801/WH	12801/G	12801/GS
Scatola multi-serie da parete con placca IP40 3M <i>Multi-series surface mount box with cover plate IP40 3M</i> 96,0 x 96,0 x h 20,0 mm			Scatola multi-serie da parete 3M <i>Multi-series surface mount box 3M</i> 128,0 x 96,0 x h 51,0 mm		
CONFEZIONE / BOX: 14 PZ		IMBALLO / PACKAGE: 56 PZ	IMBALLO / PACKAGE: 38 PZ		

flat

PLACCHE LINE LINE COVER PLATES

Articolo Article	Moduli Modules	Dimensioni mm Dimensions mm	Confezione Box	Imballo Package
7402/...	 2	80,0 x 80,0 x 9,0	40 PZ	640 PZ
7403/...	 3	122,0 x 80,0 x 9,0	30 PZ	480 PZ
7404/...	 4	149,0 x 80,0 x 9,0	25 PZ	400 PZ
7407/...	 7	208,0 x 80,0 x 9,0	20 PZ	320 PZ
Il codice completo è composto da codice articolo e "colore" Esempio: 7403/WH		The complete code is composed by the article number and the color code Example: 7403/WH		
I colori Betulla e Legno Chiaro hanno il codice 741x/BT e 741x/LC		The colors Birch Wood and Light Wood have P/N 741x/BT and 741x/LC		

Colori base / Simple colors

		
WH - Bianco / White 	N - Nero notte / Night black 	A - Avorio / Ivory 

Legno / Wood

	
BT - Betulla / Birch wood 	LC - Legno chiaro / Light wood 

flat



Colori / Colors



AS - Argento satinato / *Satin silver* 

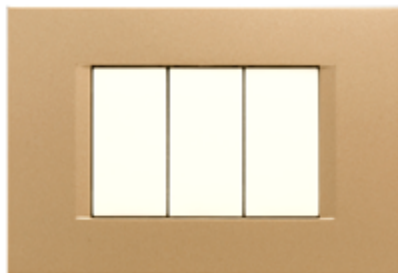

OS - Oro satinato / *Satin gold* 

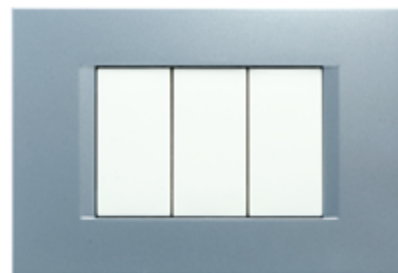



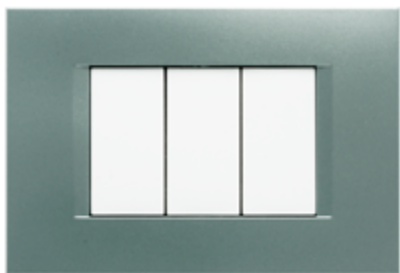

AZS - Azzurro satinato / *Satin light blue* 

















MS - Menta satinato / *Satin mint* 



NG - Nero glittering / *Glittering black* 

Articolo Article	Moduli Modules	Dimensioni mm Dimensions mm	Confezione Box	Imballo Package	
7412/...		2	80,0 x 80,0 x 9,0	40 PZ	640 PZ
7413/...		3	122,0 x 80,0 x 9,0	30 PZ	480 PZ
7414/...		4	149,0 x 80,0 x 9,0	25 PZ	400 PZ
7417/...		7	208,0 x 80,0 x 9,0	20 PZ	320 PZ
Il codice completo è composto da codice articolo e "colore" Esempio: 7413/AQ			The complete code is composed by the article number and the color code Example: 7413/AQ		

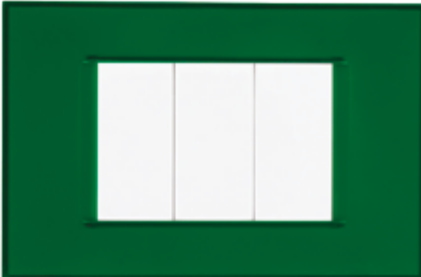
Colori / Colors

		
AQ - Acquamarina / Aquamarine 	MI - Miele / Honey 	RR - Rubino / Ruby 
		
TA - Tabacco / Tobacco 	GF - Grigio fumo / Smoke grey 	CR - Cristallo / Crystal 
		
OB - Oceano blu / Ocean blue 	VS - Verde smeraldo / Emerald green 	



CONDIZIONI GENERALI DI VENDITA E GARANZIA

Il COMMITTENTE accetta tutte le condizioni di vendita sotto indicate all'atto del conferimento dell'ordine. Le forniture sono regolate dalle seguenti condizioni generali, salvo deroghe risultanti da esplicito accordo scritto. Le forniture non sono impegnative se non confermate da FEB ELETTRICA SRL.

1. Prezzi

I prezzi indicati nel listino in corso si intendono per merce Franco nostra fabbrica. Gli imballi sono fatturati al costo, ma sono compresi nel prezzo e non si accettano di ritorno.

In caso di variazione dei prezzi della materia prima o di qualsiasi elemento di costo, ci riserviamo il diritto di aggiornare i prezzi senza obbligo di preavviso da parte nostra.

2. Ordini

Gli ordini, per essere considerati validi, devono pervenirci in forma scritta riportando per ogni articolo, codice, descrizione e quantità. Le conferme d'ordine verranno redatte da parte di FEB Elettrica secondo il listino in vigore al momento dell'emissione delle medesime e dovranno essere approvate dal Cliente entro 3 gg lav., nulla ricevendo si riterranno tacitamente approvate. Il porto franco è concesso solo per ordini superiori a euro 500. Il termine di consegna indicato non impegna la Ditta venditrice, la quale non è tenuta a risarcire eventuali danni dovuti ai ritardi di consegna, né alla risoluzione parziale o totale della fornitura.

3. Confezioni

Si possono accettare ordini con quantità minime diverse da quelle indicate nel catalogo, in questo caso FEB Elettrica si riserva il diritto di applicare un sovrapprezzo.

4. Trasporti

La merce, anche se venduta franco destino, viaggia sempre a rischio e pericolo del Committente, il quale è tenuto ad accettare con riserva i colli che non dovessero presentarsi integri al momento della consegna.

5. Reclami

Eventuali reclami dovranno essere comunicati entro 8 giorni dal ricevimento della merce.

Il reclamo non dà diritto alla sospensione dei pagamenti. Non si accettano ritorni di merce se non espressamente autorizzati per iscritto dalla vostra sede. I Resi preventivamente autorizzati per iscritto devono pervenirci esclusivamente in porto franco. L'accredito per le merci rese sarà definitivo dopo l'avvenuta presa in carico presso nostro magazzino e dopo aver verificato quantità e qualità degli articoli segnalati.

6. Pagamenti

Il pagamento della fornitura viene effettuato nella forma espressamente specificata, concordata e riportata in conferma d'ordine. Non si accettano arrotondamenti. Interessi di Mora: i pagamenti ritardati od omessi rispetto alle condizioni pattuite, saranno soggetti agli interessi legali che decorreranno dal primo giorno di mancato o ritardato pagamento oltre all'addebito di eventuali oneri accessori e salvo ulteriori azioni a tutela.

7. Informazioni sui prodotti

Le informazioni e le immagini riportate nei cataloghi e nelle pubblicazioni hanno scopo puramente informativo ed illustrativo. FEB ELETTRICA s.r.l. si riserva il diritto di variare le caratteristiche tecniche dei prodotti. I prodotti devono essere installati ed usati nel rispetto delle caratteristiche tecniche secondo le disposizioni di sicurezza previste dalle normative vigenti.

FEB ELETTRICA SRL non è in alcun modo responsabile dei danni a beni o persone derivanti dall'uso improprio dei propri prodotti, dall'inosservanza delle norme di sicurezza, delle istruzioni per l'uso e delle specifiche tecniche.

8. Condizioni di garanzia

La garanzia sui prodotti nei confronti del consumatore finale si intende ai sensi della legislazione vigente al momento dell'acquisto. FEB ELETTRICA SRL estende detta garanzia di un totale di 5 anni dalla data di acquisto esclusi i prodotti relativi alla domotica. Il consumatore può far valere tali diritti nei confronti del venditore, alle condizioni e nei termini previsti dalla legge. In ogni caso, per far valere la garanzia, l'interessato deve denunciare per iscritto il difetto di conformità al venditore entro il termine di due mesi dalla data della scoperta, a pena di decadenza.

In caso di difetto di conformità dei prodotti venduti, il consumatore potrà richiedere la riparazione o sostituzione dello stesso. FEB ELETTRICA SRL si impegna a garantire la riparazione o sostituzione gratuita del bene non conforme.

È compito del consumatore finale dimostrare la validità della garanzia, attraverso un documento di consegna rilasciato dal venditore che riporti nominativo del venditore e la data in cui è stata effettuata la vendita. La garanzia non si applica in tutti i casi di uso improprio del prodotto o in tutti i casi in cui la non conformità non sia attribuibile direttamente a FEB ELETTRICA SRL.

9. Controversie e responsabilità

Per qualsiasi controversia è competente il foro di Bologna.

10. Protezione dati personali

Le informazioni richieste da FEB ELETTRICA SRL agli acquirenti sono indispensabili per trattamento alla convalida degli ordini, l'emissione delle fatture e dei contratti di garanzia. FEB ELETTRICA SRL gestisce tutti i dati relativi ai suoi clienti secondo quanto prescritto dalla normativa di cui al Decreto Legislativo del 30 giugno 2003 numero 196, relativo al "codice in materia di protezione dei dati personali".

Il titolare del loro trattamento è la società FEB ELETTRICA SRL ubicata in via Pollastri, 1 - 40138 Bologna.

11. Colori rappresentati

Le gamme colori sono puramente indicative, potranno essere soggette a tolleranze di tonalità, tecnicamente impossibili da eliminare, perchè prodotti in momenti diversi, quindi, non contestabili.

GENERAL CONDITIONS OF SALE AND GARANTUEE

The Customer accepts all the terms of sale indicated below at the moment of issuing the order. The supplies are regulated by the following general conditions, excluding exceptions resulting from explicit written agreement. The supplies are not confirmed without a written document from FEB Elettrica s.r.l.

1. Prices

The prices indicated in the price list are "ex works" at our Factory. Packings are invoiced at their cast, they are included in the price and they are not accepted back. In case of variation of the prices of the raw materials or of whichever element of cost, we reserve the right to modify the prices without obligation of warning time.

2. Orders

For an order, to be considered valid, it must be received in writing by FEB and indicate for each item the P/N, description and quantity. The order confirmation will be filled out by FEB according to the price list that is valid in that moment and will need to be approved by the Customer within 3 working days from receipt. The order confirmation will be considered automatically approved if no communication will be sent back to FEB before the end of the 3rd working day after receipt. Free transport is only for orders above 500 €.

The indicated term of delivery does not oblige the selling Company, which is not held to reimburse any damages due to delivery delays, or to the partial or total cancellation of the supply.

3. Packing

It is possible to order quantities that are smaller than the minimum amount indicated on the catalog, but a surcharge for the processing might be added.

4. Transports

The goods, even if sold at destination, always travel at the risk and danger of the Customer, who will be responsible to accept with reserve the packages that might look damaged upon delivery.

5. Claims

Claims will have to be communicated within 8 days from the reception of the goods. The claim does not give right to the suspension of the payments. The return of the goods is not accepted without a written authorization from our offices. The authorized returned products must reach us free of charge. The credit for the goods will be defined after we receive them at the warehouse and after we have checked the goods returned and their quality and quantities.

6. Payments

The payment of the supply is done in the specified and agreed terms, at the address of FEB Elettrica s.r.l. The Customer bears all the risks for the delivery of the payment, for any form of payment. Rounding is not accepted. Default interest: payments that are delayed or missed with respect to the agreed upon conditions, will be subject to legal interests. The interests will be effective from the first day of either missed or delayed payment and will be in addition to other related charges and will not prevent the pursuit of further necessary actions. Default interest: payments

that are delayed or missed with respect to the agreed upon conditions, will be subject to the legal interests. The interests will be effective from the first day of either missed or delayed payment and will be in addition to other related charges and will not prevent the pursuit of further necessary actions.

7. Information about the products

The information and the images contained in the catalogs and other publications only have the purpose of providing information about and illustrating the products. FEBELETRICA s.r.l. reserves the right to modify the technical characteristics of the products. The products must be installed and used in accordance to the technical specifications and according to the safety rules of the electrical material used in the Country where the products are installed or used.

FEB ELETRICA s.r.l. is in no way responsible for the damages to goods or people that are a consequence of improper use of the products, by not following the safety specifications, the usage instructions and the technical specs.

8. Conditions of guarantee

The guarantee on the products towards the final customer is referred to the legislation existing at the moment of the purchase. FEB Elettrica extends the guarantee up to 5 years from the date of the purchase excluding the smart home products. The Customer can exercise such rights toward the Vendor, at the conditions and in the terms stated by the law. In any case, in order to exercise the guarantee, the customer must declare with a letter the defect of conformity to the vendor within the term of two months from the date of the discovery, or the guarantee will not be valid. In case of defect of conformity of the sold products the Customer will be able to demand the repair or substitution of the some product. FEB Elettrica s.r.l. is committed to guarantee the repair or free substitution of the non conforming good. It is a task of the final Consumer to demonstrate the validity of the guarantee, by a document of delivery from the vendor with the name of the vendor and the date in which it has been sold. The guarantee is not applied in all the cases of improper use of the product or in all the cases in which the conformity defect is not directly attributable to FEB Elettrica s.r.l.

9. Controversy and responsibility

For whichever controversy the Court of Bologna (Italy) is competent.

10. Protection of personal data

The informations asked by FEB Elettrica s.r.l. to the Customers are indispensable for the treatment and the validation of the orders, the emission of the invoices and of the guarantee contracts. FEB Elettrica s.r.l. manages all the data related to its customers according to the Legislative Decree of June the 30th 2003, n°196, "Norms for protection of the personal data". The "holder" of their treatment is the company FEB Elettrica s.r.l., located in via A. Pollastri, 1- 40138 Bologna (Italy).

11. Color ranges

Color ranges are purely indicative, they may be subject to color tolerances, technically impossible to eliminate, because they are produced in different times, so, they are not contestable.





La sicurezza e qualità dei prodotti sono garantite dalle certificazioni internazionali di prodotto e dalla certificazione UNI EN ISO9001 :2015 e permettono a FEB di fornire una garanzia di 5 anni.

The safety and quality of the products are guaranteed by the international product certifications and by the UNI EN ISO 9001:2015 certificate and allow FEB to give 5 years of warranty.



FEB Elettrica S.r.l.

Via Augusto Pollastri, 1 - 40138 Bologna (BO) - Italia

febelettrica@febelettrica.it

Tel. +39 051 6025234 - Fax: +39 051 534412

UFFICI COMMERCIALI MILANO

Via Pietro Andrea Saccardo, 9 - 20134 Milano (MI) - Italia

febelettrica@febelettrica.it

Tel. +39 051 6025234 - Fax: +39 051 534412



FEB Elettrica S.r.l.

Via Augusto Pollastri, 1 - 40138 Bologna (BO) - Italia

febelettrica@febelettrica.it

Tel. +39 051 6025234 - Fax: +39 051 534412

UFFICI COMMERCIALI MILANO

Via Pietro Andrea Saccardo, 9 - 20134 Milano (MI) - Italia

febelettrica@febelettrica.it

Tel. +39 051 6025234 - Fax: +39 051 534412



Visita il nostro sito web

febelettrica.it